



SAKO

**WASTE INCINERATION PLANT
IN BRNO**



WHAT
WASTE-TO-ENERGY
BRINGS

WASTE MANAGEMENT HAS BEEN DEALT WITH BY THE HUMAN SOCIETY FOR OVER THREE MILLENNIA AND FOR THE EVER GROWING MUNICIPAL AGGLOMERATIONS THE USE OF WASTE-TO-ENERGY IS ONE OF THE MEANINGFUL WAYS. THE ENERGY USE OF MUNICIPAL WASTE IS NOT ONLY ABOUT ITS INCINERATION.

The modern facility of the Brno incineration plant utilises municipal waste to generate steam, hot water and electricity. The steam can cover up to 30 % of the annual consumption in the city of Brno. However, unlike in heating stations, fossil fuels are not used to generate steam, which results in significant savings in primary non-renewable raw materials. Thanks to the selected technical solution including the new steam extraction condenser turbine, we can flexibly change the ratio between the volume of steam delivered to the central heat supply system and electricity generation based on the current energy demand.

Thus, this system maximises the use of energy released from waste incineration. Highly efficient five-stage system of flue gas treatment makes sure that the flue gases vented out through the stack meet the stringent emission limits even with a margin. The emission limits concerning the individual pollutants following the Czech regulations are identical with the limits applied in industrially developed European countries. The product of the incineration process – slag – is conveyed through a separation system. During the process, ferrous as well as non-ferrous metals are separated to be recovered, they are then sorted according to several fraction sizes and used to technically secure landfill sites for the future application as construction material.

The Waste Management Brno project supported by funds provided by the European Union resulted in the construction of an integrated waste management centre which reflects the modern methods of waste management and trends in separation and recycling. Besides the increasing number of separated waste collection points in Brno, a pre-sorted waste final sorting line was installed at the incineration plant. It ensures post-sorting of plastic materials, paper, beverage cartons and aluminium packaging in order to guarantee the highest possible quality of these raw materials for subsequent recycling. Furthermore, the line is variable and in the future it may be used for final sorting of other recyclable types of waste in the future based on the market requirements.

The image shows a waste incineration plant under a blue sky with light clouds. On the left, a tall metal lattice tower supports several power lines. On the right, a tall, grey chimney with red and white horizontal stripes is visible, with the word 'SAKKO' written vertically on it. In the background, a city skyline is visible. A large blue circle is overlaid in the center, containing the text 'WASTE INCINERATION PLANT' in white, bold, sans-serif font. A blue arrow points from the left edge of the image towards the circle.

WASTE INCINERATION PLANT



MAIN ADVANTAGES OF THE INCINERATION PLANT

- ▶ utilisation of the released heat energy from waste incineration to produce steam, hot water and electricity;
- ▶ savings in the primary non-renewable raw materials and energy;
- ▶ separation of ferrous scrap and non-ferrous metals from mixed municipal waste following incineration and recovery in the form of secondary raw materials;
- ▶ perfect waste burnout to inert organic material – slag with a minimum volume of organic residues (1–5 %);
- ▶ reduction in weight down to 25 % of the original values;
- ▶ reduction in the volume down to 10 % of the original values , which represents 10 times extended service life of the landfill site;
- ▶ efficient separation of monitored pollutants from flue gases while meeting the most stringent emission limits set by the EU;
- ▶ incineration of municipal waste without necessary pre-treatment;
- ▶ simple and efficient control of the incineration process;
- ▶ major reduction in produced fossil CO₂, which greatly contributes to the so-called global warming compared to heating or el. power stations.

ONCE YOU THROW YOUR WASTE IN THE DUSTBIN YOU HARDLY EVER THINK WHAT WILL HAPPEN WITH THE WASTE NEXT. IN BRNO, THE WASTE IS COLLECTED IN AN INTEGRATED WASTE MANAGEMENT CENTRE.

This is a technologically sophisticated process where waste that would otherwise be landfilled is incinerated in a controlled way at high temperatures and the energy released from the process is recovered to produce steam. The steam drives turbine blades generating electricity. A part of the steam is extracted as a heat-carrying medium to the central heat supply system of the city of Brno or into a heat exchanger station to heat water used as the heat-carrying medium for hot water pipelines.

BASIC OPERATING PARAMETERS OF THE INCINERATOR

- ▶ Two incineration boilers producing steam at a pressure of 4 MPa and a temperature of 400 °C
- ▶ Volume of incinerated waste:
 - 14 t/h at waste calorific value of 11–13 MJ/kg
 - or 16 t/h at waste calorific value of 8–9.5 MJ/kg
- ▶ Efficacy 85 %
- ▶ Fully automatic incineration
- ▶ Capacity 248,000t of waste a year
- ▶ Use of produced waste:
 - supplies to the CZT (central heat supply system)
 - hot water production
 - el. energy production
 - internal consumption



TECHNOLOGICAL PROCESS



WEIGHING MACHINE

The input civil structure for all vehicles bringing waste to the waste incineration plant is the weighing station with a gamma radiation detection system. The detectors are designed to detect sources of ionising radiation or radioactive substances in case of illegal or undesirable transport of these substance along with the collected waste and thus restrict the consequences of accidents that might occur as a result of these substance escaping into the environment. The waste is conveyed from the weighing machine either to the post-sorting line, if these are municipal waste materials recoverable from the separated waste collection system introduced in the municipalities, or to the waste bunker for energy recovery. Operators at the inlet check the incoming waste and in case of non-conformities the waste cannot be filled in the waste bunker.

If bulky pieces of waste are brought on site, the waste is stored in a hall with a rotary crusher, crushed first to the required size and the treated waste then falls directly into the waste bunker.

WASTE BUNKER

The waste bunker is a reinforced concrete structure which can hold up to 5,000t of mixed municipal waste generating, at the maximum boiler output, an operating reserve for 7 days. Slightly negative pressure is maintained in the bunker to suck out the air used in the incineration process as primary air. This also prevents from odour nuisance and dust spreading in the immediate vicinity of the incinerator. The crane operator uses a polyp grab to extract waste from the inlet chutes and homogenises waste in the bunker and fills hoppers of the individual boilers. In the waste bunker there are two stable water canons to put out any incidental fire.

TECHNOLOGICAL SCHEME

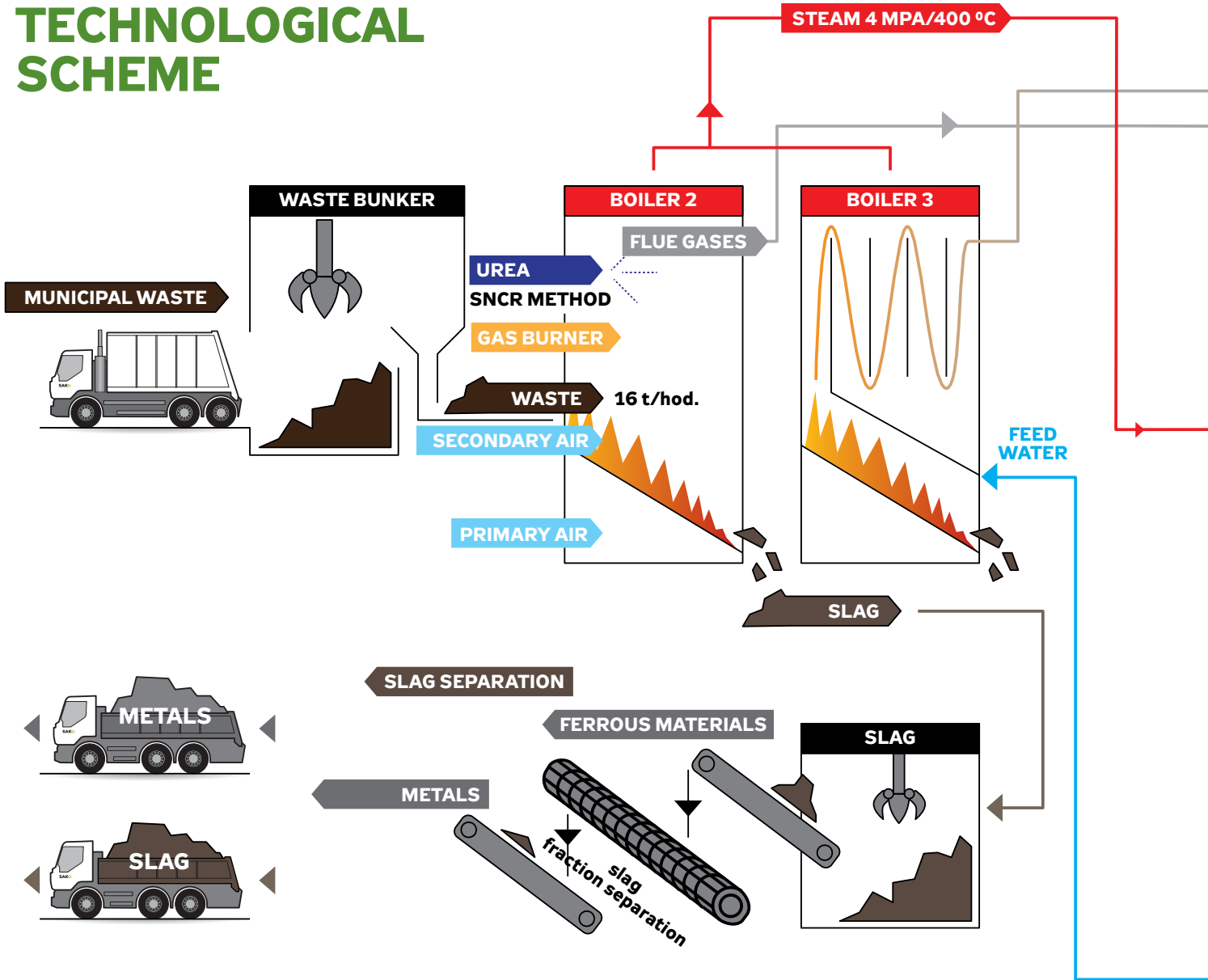

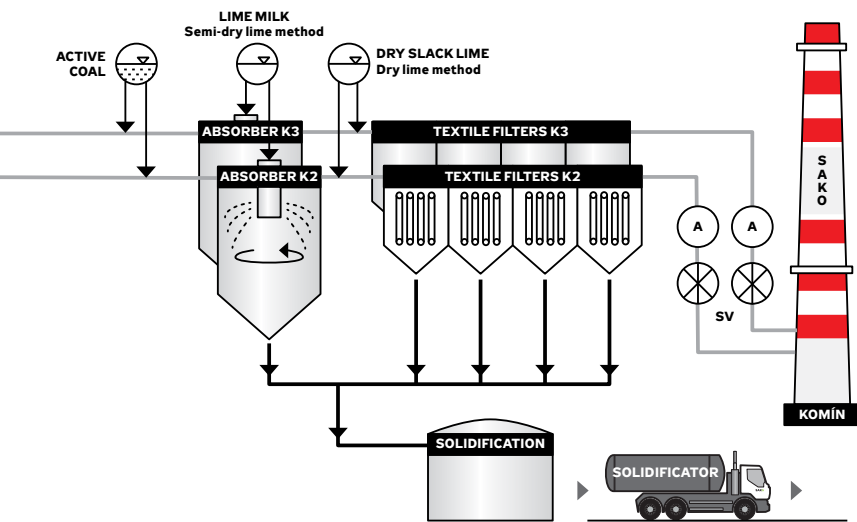

- NVK** – RETURN CONDENSATE TANK
- NDV** – DEMI WATER TANK
- NN** – FEEDING TANK
- NPK** – OPERATING CONDENSATE TANK
- RO** – CONTROLLED EXTRACTION
- NRO** – UNCONTROLLED EXTRACTOR
- KUP** – SEAL STEAM CONDENSER
- RS** – PRESSURE REDUCTION STATION
- SV** – FLUE GAS VENTILATOR
- A** – ANALYSERS
- VS** – INTERNAL TECHNOL. CONSUMPTION
- TUV** – HOT SERVICE WATER

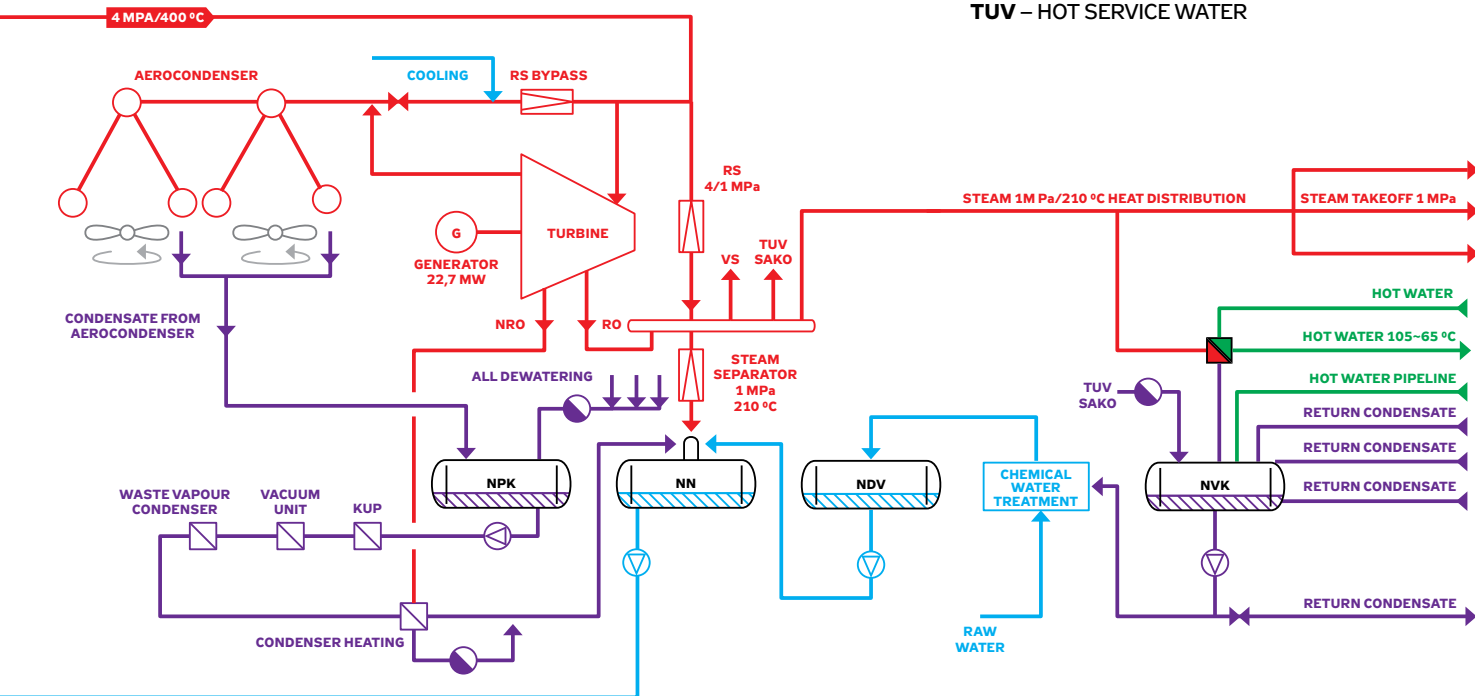

BOILERS

Waste from the input boiler hopper passes through a gravity shaft and it is dosed by means of a feeding system with a hydraulic drive to the boiler incineration grate.

Each boiler is fitted with an incineration reverse grate developed specifically for solid municipal waste incineration. The surface area of each grate is 45.5 m². Waste is kept on the grate for the average of 20 minutes. Waste on the grate shifts and turns by the movement of the grate bars „against“ the grate inclination and waste movement direction which ensures perfect burnout of combustible waste components.

The main parameters to set optimal incineration mode on the grate is waste dosing, waste movement on the grate and volume of supplied air. The technology makes it possible to set up the incineration mode on the grate in specific zones within a wide range of the incinerated waste calorific values. The incineration chamber has an evenly distributed temperature field achieving maximum temperature of flue gases of 850 °C for two seconds in order to ensure perfect oxidation of biogenic elements – nitrogen, carbon, hydrogen and sulphur. The high temperature also ensures perfect burnout of organic matter so as to avoid follow-up recombination resulting

in thermo-stable substance that could be more harmful than the original organic substances in the waste. The oxidation process results in exothermic reaction releasing maximum volume of heat energy.

The boiler itself is of a water-tube type with natural circulation of a three-pass design with two drums and evaporator bundle in the third pass and two-stage economiser with the first stage installed outside the boiler room. It is designed in a way ensuring sufficient combustion product retention time in the boiler combustion chamber to ensure perfect burnout of the combustible waste components while ensuring low emissions of carbon monoxide and nitrogen oxides.

The boilers are designed to ensure maximum reduction in the flue gas flow velocity along the heat-generating surfaces to ensure perfect maximum steam output of the boiler while minimising clogging and abrasion of internal surfaces. The operation is controlled from the central control room. To start up from the cold condition it is necessary to heat up the combustion chamber first to a temperature of 850 °C using a natural gas burner. Waste fed to such a pre-heated combustion chamber flares up immediately and no additional fuel is required for the burning process.

The released heat energy is transmitted to the boiler boiling system producing steam at a pressure of 4 MPa and a temperature of 400 °C.



TECHNICAL PARAMETRES OF THE BOILER:

MAXIMUM BOILER INCINERATION RATE:
16 t/h

MINIMUM INCINERATION OUTPUT:
8 t/h

MAXIMUM STEAM OUTPUT:
55 t/h

NOMINAL STEAM OUTPUT:
45 t/h

NOMINAL SUPERHEATED STEAM PRESSURE:
4 MPa

NOMINAL SUPERHEATED STEAM TEMPERATURE:
400 °C

NOMINAL FEED WATER TEMPERATURE:
160 °C

INCINERATOR CAPACITY:
248,000 t of waste/year at a calorific value of 8–9.6 MJ/kg





TURBINE

Steam is extracted by a bleeder condensing turbine where it expands and operates mechanically through the blade rotor drive. The rotor is connected with a gearbox and generator transforming mechanical energy into electric energy. When passing through the turbine, the steam pressure and temperature drop and the steam is extracted by the so-called controlled extraction to a medium pressure distributor and then to the central

heat supply system. It is also used to heat up service spaces in the incinerator, to maintain vacuum in the condenser, to heat up service hot water and to pre-heat primary combustion air.

Steam from the non-regulated extraction is used to heat process media, i.e. condensate. Unused steam leaving the turbine is conveyed to the air cooled condenser where its state changes back to water and it is reused in the steam production process.

The genset may also be used in the so-called „island mode“. During outage, the turbine may generate electricity covering the internal consumption of the incineration plant. If the turbine may not be operated for whatever reason, all the produced steam may be reduced to a pressure corresponding to the medium-pressure steam distributor and the steam may be supplied to the central heat supply system (CZT), or the entire volume may be condensed in an air condenser.

COMBUSTION PRODUCT COMPOSITION

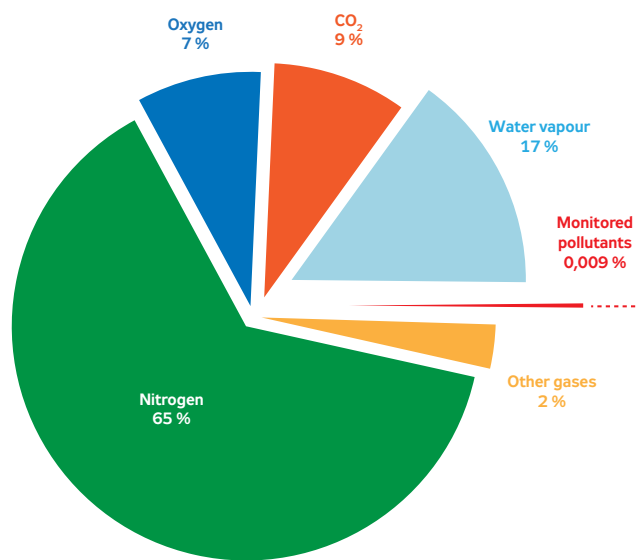

POLLUTANT COMPOSITION (output from authorised boiler K3)

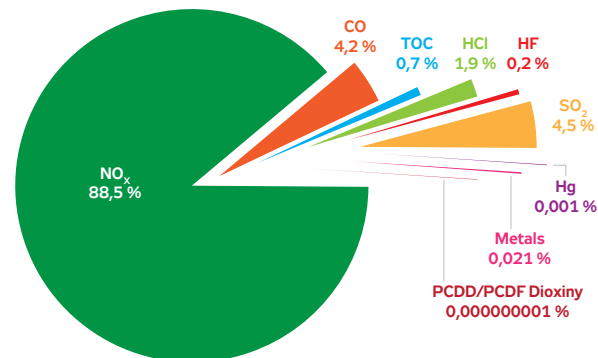

CHEMICAL WATER TREATMENT

Feed water for the boilers consists mainly of return condensate from the CZT system, pure condensate from the air cooled condenser and water from chemical water treatment plant using largely potable water from the public water supply system and water from hydrogeological wells located on site. The chemical water treatment plant is fitted with a demi station with two lines with a total delivery of 40 t/h of demineralised water. Demineralisation is based on counter current ion exchanger technology featuring lower specific consumption

of the regeneration agents and higher quality of treated water. Treated demi water is stored in two tanks.

Waste water from the chemical water treatment plant is collected in a retention tank following neutralisation and further technological water treatment. Water from the retention tank is used in the slag cooling technology.

SLAG LINE

Slag is transported from the wet extractor by a system of belt conveyers to a concrete underground tank with a capacity of 812 m³. From the tank it is transported by

a bridge crane to the sorting line hopper from where it is carried by other belt conveyers to a drum sorting system and then to an electromagnetic separator where ferromagnetic fractions are separated.

The slag fractions below sieve size pass through another drum sorter, iron separator and non-ferrous metals separator based on the principle of induction currents. Sorted iron and aluminium are transported off site as secondary raw materials for further reuse. Various slag fractions containing ca. 20 % of water are transported via a system of conveyers mainly to the available skips or

COMPARISON OF BASIC STATUTORY EMISSION LIMITS WITH VALUES MEASURED AT BOILER K2 – SAKO INCINERATOR

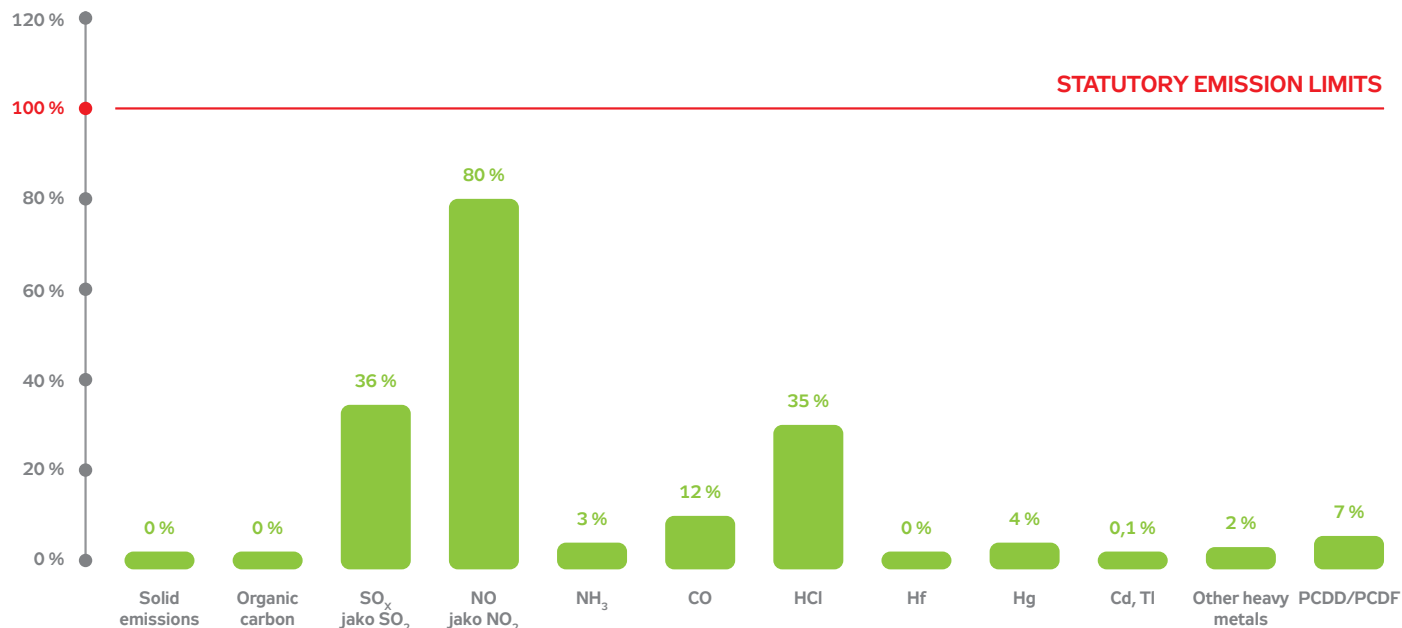

Average weight concentration values at SAKO Brno, a.s., in 2014

directly onto trucks. The slag is used for technical securing of landfill sites or it is disposed of in a dedicated landfill.

FLUE GAS TREATMENT

Each boiler is fitted with a system reducing nitrogen oxides concentrations in flue gases, based on the principle of selective non-catalytic reduction (SNCR). This

method uses reduction properties of an aqueous solution of 40% urea which is injected in the combustion chamber within the flue gas temperature band of 950–1100 °C. Chemical reactions at high temperatures do not call for catalyst and thermic and fuel nitrogen oxides are reduced back to nitrogen.

Flue gases produced during waste

CHEMICAL REACTION IS EXPRESSED BY THE EQUATION:

Oxidation:



Reduction:

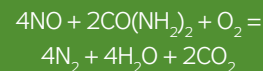

incineration have a temperature of 195 °C at the boiler outlet and are extracted from the boiler by a flue-gas duct to the top of the absorber. The flue gas treatment system is based on a semi-dry lime method and along with technical and operational measures it addresses the issue of heavy metals, dioxins and other persistent organic pollutants. The semi-dry lime method CNIM-LAB consists in the spraying of finely dispersed water lime suspension in a flow of flue gases at a temperature of 195 °C. The result is a series of chemical reactions taking place during gradual water evaporation between the co-current of gaseous hot acid components of flue gases and alkali sorbent, which is lime milk aerosol.

The result is a very fine powder separated from flue gases on textile filters. Activated carbon is driven under pressure into the flue duct of each line upstream absorbers and the activated carbon surface binds heavy metals and dioxins which were not eliminated in the previous fly ash, products of neutralisation reaction and residues of non-reacted agents are conveyed by the flue duct to the textile filter. Treated flue gases void of mechanical impurities are subject to

continuous analyses before entering the stack. Cleaned flue gases are vented to the atmosphere through a single stack with a height of 125 metres, with three separate stack linings.

The entire treatment process is controlled by a control system automatically so as to ensure constant flue gases temperature at the outlet and to ensure the residual content of pollutants below the permissible emission limits. The dust fractions in the flue gases treatment process contain a volume of heavy metal salts that could be carried as a result of weather conditions outside the disposal site or leached as a result of acid rains. Therefore, these adverse phenomena are prevented from by solidification either in our technological line or by external contractors. In the solidification plant the waste product from the flue gases treatment system is mixed with cement and water used as a binding agent. Most heavy metals are not soluble in such alkali environments. All pollutants are then firmly mechanically or chemically bound, which prevents from leaching into the disposal site.



FLUE GAS TREATMENT SEPARATION STAGE

1. STAGE: selective non-catalytic reduction of nitrogen oxides (SNCR): urea spraying at two levels of first ducts of each boiler

2. STAGE: activated carbon distributor (AC): concentrated into the flue duct between the boiler and absorber in order to reduce the content of persistent organic matter from flue gases (persistence is the ability of substance to persist in the environment for a long time) and heavy metals

3. STAGE: semi-dry lime method: vertical reactor operating on the principle of flue gas co-current and spray of dispersed lime milk suspension to neutralise acid components in flue gases

4. STAGE: dry lime method: dry hydrate dosing during the semi-dry lime method outage or to boost it to remove acid components in flue gases

5. STAGE: textile filters (TF): system removing solid mechanical pollutants from flue gases and treatment reaction products.



LOOKING BACK
AT THE HISTORY
OF WASTE
ENERGY USE

WASTE HAS ACCOMPANIED THE MANKIND SINCE TIME IMMEMORIAL. THE QUESTION OF WASTE DISPOSAL AROSE ONCE PEOPLE SETTLED AND STARTED BUILDING THE FIRST CITIES. THE ABSENCE OF SEWERAGE AND FAILURE TO ADDRESS WASTE DISPOSAL TRIGGERED A NUMBER OF EPIDEMICS IN THE PAST.

BEGINNINGS OF WASTE DISPOSAL

The industrial development in the 19th century and ever growing municipal agglomerations necessitated intensive attention paid to the waste issue. First sewerage systems are developed, waste collection is organised and land disposed of on the outskirts of cities. With the rising solid waste volumes, the solid waste landfills are soon insufficient and waste incineration is the clear option. The pioneer of this trend was the largest global industrial power of that time- Great Britain. The first large incinerators were built in Leeds, Manchester and Birmingham between 1876–1878. The first important incinerator on the European continent started operating in Swiss Zurich and it was constructed by the British company Horsfall-Destructor- Company. This facility could incinerate over 130 tons of waste a day.

FIRST INCINERATION PLANT IN THE AUSTRO-HUNGARIAN EMPIRE WAS BUILT IN BRNO

At the beginning of the 20th century, the city of Brno had more than 100,000 inhabitants and struggled with similar problems as most large European cities. Municipal waste was brought to the outskirts of the city where a number of landfills were established. The capacity of the landfills was soon exhausted and they also posed a great problem in relation to hygiene and health risks. The father of the idea of building an incinerator in Brno is considered to be Brno councillor, professor Max Höning. The former city management supported the idea and on 17th May 1904 a decision was made to build an incinerator in Radlas street.

In June 1904, the design was ready and in the autumn of the same year the construction started. The Brno incineration

plant (formerly derived from the word rubbish and called rubbish plant) was commissioned on 25th August 1905. This made it one of the first modern incineration plants in Europe and the first incinerator in the Austro-Hungarian empire.

During its time, this plant was an edge-cutting facility which did not only burn the waste but also recovered waste for electricity generation. The rubbish plant was equipped with a combustion furnace divided into seven combustion chambers. The system was developed by Alfons Custodis from Vienna and had already been used in incineration plants installed in Germany. Waste was first crushed between two cylinders from where it was conveyed to a bunker.

From the bunker it was manually shovelled to a feeder feeding the individual combustion chambers. The incineration process itself took 45 minutes. Already

at that time, the primary purpose was waste inertisation, and produced heat was used to generate electric energy. The combustion chambers were connected with the steam boiler and the produced steam drove the Parson turbine with a turbo-generator producing alternating current. Slag was removed from the furnace by means of iron bars and was conveyed to cooling towers. Cold slag was crushed, sieved and sold as construction material. This incineration plant was in operation in Brno until the production terminated in 1941. The fate of the rubbish plant was finally sealed by allied forces bombing in April 1945, when it was demolished along with the nearby gas plant.

INCINERATION PLANT IN THE 20TH CENTURY

Immediately after the end of WWII, construction of a new incinerator was considered. The reasons were the inadequacy of land filling the waste, waste hygienic treatment and the possibility of recovering waste energy for heating purposes. It took more than 40 years before this project was implemented.

In 1984, the construction of a municipal waste incinerator in Jedovnická street started and its first boiler was put into

operation in January 1989.

The main contractor supplying technology was ČKD Dukla Praha and the general contractor of the construction part was Průmyslové stavby Brno. The new boiler room was fitted with three three-pass membrane boilers ČKD DUKLA Praha with a maximum use of the internal walls to enable perfect heat transfer to the boiler boiling system with single-drum boilers with natural circulation. Six cylindrical Düsseldorf system grates arranged in a descending order ensured continuous operation of the installation. The grate was designed so that each of the six cylinders was fitted with its own drive for revolutions control and separate controlled air feed to the cylinder. Waste fed to the first cylinder was controlled by the feed table velocity.

Heat energy released during waste incineration was used for steam production for technological purposes and it also supplied heat to the central heat supply system in Brno. Later, an installed back-pressure reduced steam turbine was used to generate electricity covering 20 % of internal consumption.

When commissioned, the new Brno incinerator was only equipped with the first flue gas treatment stage consisting of

solids separation from flue gases using

electrostatic separators. These were vertical two-section electric filters with the efficiency of the first section of 95 % and the second section of 4.9 %.

In 1994, blowers were installed under the electric filters where compressed dry air was used to transport separate fly ash to the solidification stage and fly ash silo. In May 1994, the second flue gas treatment stage was completed at the incineration plant based on the semi-dry lime method. As part of the construction of the second flue gas treatment stage, the solidification unit was installed in a separate building where fly ash from electric separators and solid reaction products, the so-called "end-products" were processed, from the secondary flue gas treatment along with cement and water into cement mixture. In 2004, the fifth flue gas treatment stage was added to reduce nitrogen oxides by means of selective non-catalytic reduction.

More stringent technical requirements for waste-to-energy, new standards and unstable situation concerning thermal energy demand resulted in a radical step taken in 2000- reconstruction and extension of the incinerator as part of the Waste Management Brno Project.

A photograph of a Sakko power plant. A tall, white and red striped chimney stands prominently in the center, with the word 'SAKKO' written vertically on it. In the foreground, there is a large green circle with a white arrow pointing to the left. Inside this circle, the text 'CLEANNESS AND ENERGY FOR YOU' is written in white, bold, sans-serif capital letters. The background shows the industrial complex with various buildings and structures under a clear blue sky.

SAKKO

CLEANNESS
AND ENERGY
FOR YOU



SAKO

SAKO Brno, a.s.
Brno, Jedovnická 2
tel.: 548 138 111, fax: 548 138 102,
e-mail: sako@sako.cz, www.sako.cz